









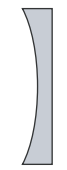
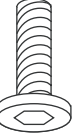

CODE	PARTS	QTY
34M	 FRAME	2
34B	 CROSSBAR	4
34C	 CROSSBAR SPACER	8
34D	 HEX SCREWS	8
34E	 HEX WRENCH	1
34F	 CASTER	2
34G	 LOCKING CASTER	2
34H	 TOP PLATE	1
34I	 SHALLOW DRAWER	4
34N	 DEEP DRAWER	2
34J	 KNOB	6
34K	 KNOB SCREW	6

**STEP 1**

- a. Make sure Drawer Rails on Frames (M) are facing each other. Snap Locking Casters (G) into same end of each Frame.
- b. Snap non-locking Casters (F) into Frames.

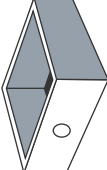

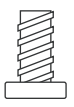
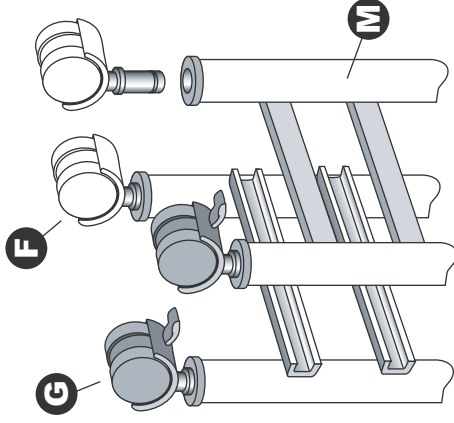
**STEP 3**

- a. Snap on Top Plate (H).

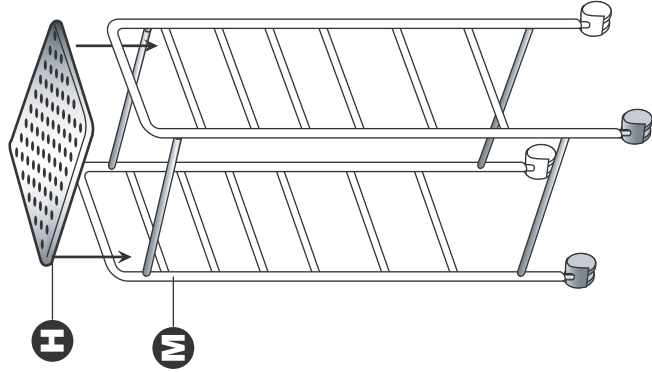

**STEP 2**

- a. Attach 4 Crossbars (B) to 1 Frame (M) using the 4 Crossbar Spacers (C) and 4 Hex Screws (D). Make sure curved side of Spacers faces Frame. Do not fully tighten screws.
- b. Attach 2nd Frame to 4 Crossbars following instructions as above.
- c. Fully tighten all 8 screws.

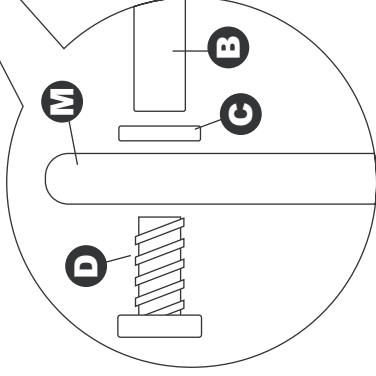

**STEP 4**

- a. Attach 6 Knobs (J) to 6 Drawers (I and N) with 6 Knob Screws (K).

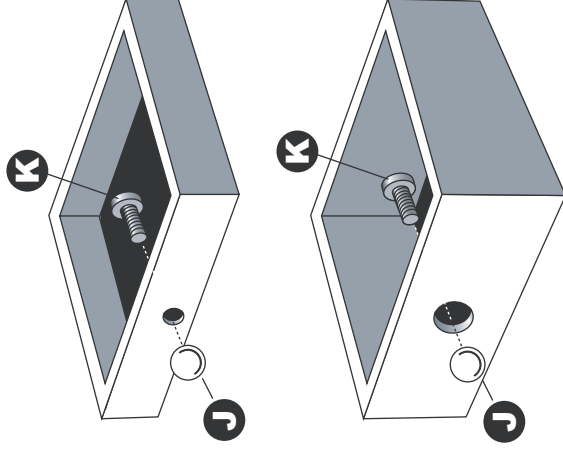

**STEP 5**

- a. Insert Drawers into rails.

